

Seminar

KABOLA BLUE EcoLine

KB-BE-Boiler- and Burner technology



General agent for KABOLA
in German-speaking countries





- Blue burner technology **Blue efficiency®**
- Best efficiency up to 94%, constant over time. For Yellow burner technology the efficiency drops with time because the Yellow burner produces soot which builds in the boiler
- Smallest dimensions specifically designed for the maritime sector
- TÜV Certification
- Certification of electromagnetic compatibility according to the GL and IEC Standards
- Best environmental values and soot figure 0.0

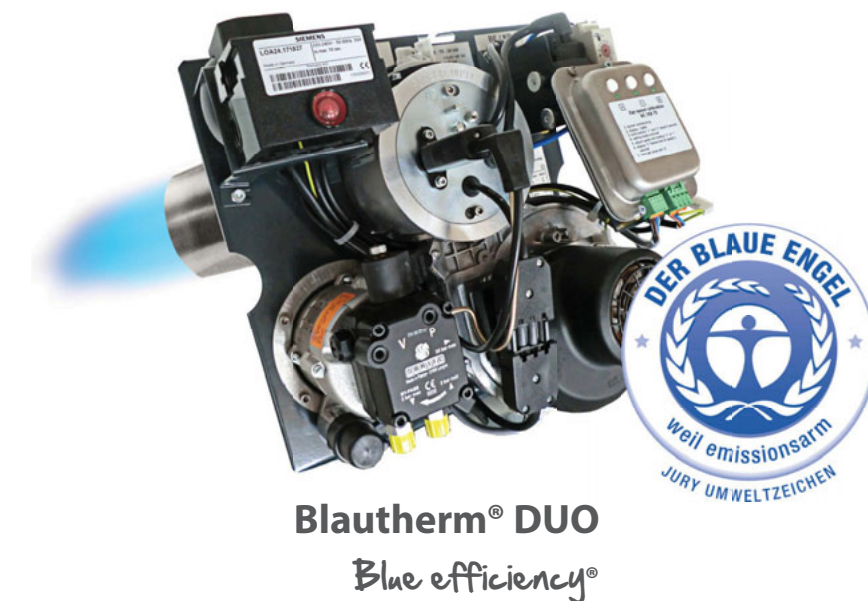

		KB 20	KB 40	KB 45	KB 50	KB 75
Operating performance	kW	7	13	24	28	38
Dimensions (H / W / D)	cm	40 / 38 / 52	42 / 38 / 62	44 / 38 / 64	52 / 43 / 70	52 / 43 / 70
Weight (standard / combi)	kg	65 / -	75 / 80	80 / 85	90 / 95	115 / 120
Efficiency	%	92	93	93	94	94
Water heating plate heat exchanger		-	Option (combi)			
Water capacity of the boiler	Liters	8.5	17.5	20.0	23.0	37.0
Fuel		Diesel / Heating oil according to DIN EN 590				
Oil flow	L/h	0.69	1.27	2.35	2.75	3.73
Oil nozzles		0.18 - 80° SC	0.25 - 80° SC	0.40 - 60° SC	0.50 - 60° SC	0.65 - 60° SC
Exhaust temperature	°C	170 - 220	150 - 200	145 - 205	145 - 200	140 - 190
	°F	338 - 428	302 - 392	293 - 401	293 - 392	284 - 374
Exhaust pipe - Ø	mm	Ø 50			Ø 80	

Operating principle of the KB-Series

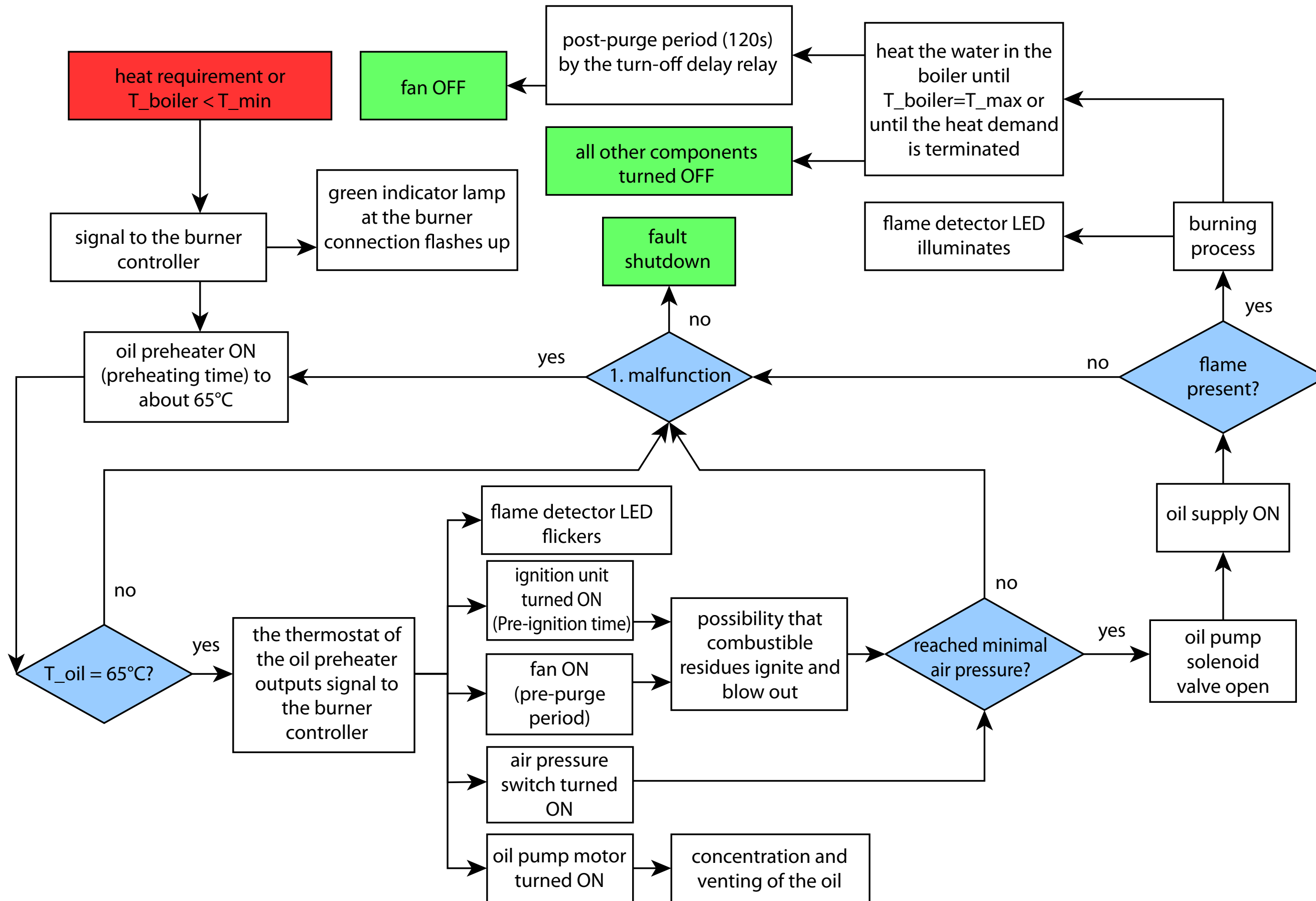

If the burner is supplied with voltage during startup, the yellow power ON delay timer starts to operate. After 120 s the voltage is forwarded to the burner controller and to the oil preheater, provided that a heat demand exists. This means that after every power interruption to the burner (eg maintenance, switch from board power to shore power) an interruption of 120 s takes place.

When the boiler control places a heat demand on the burner, a green LED illuminates in the E-distribution input (7-pin plug).

At the same time there is a voltage present at the entrance of the oil preheater. The oil preheater starts to work and heats the oil.

After a preheating interval of ca. 1 to 3 minutes, the oil preheater gives a clearance to the burner controller and the burner starts. The burner controller then initiates the operation of the fan, oil pump motor and ignition.

After a pre-purge period that is specified by the burner controller, the solenoid valve of the oil pump is driven by the air pressure switch.

Then a flame is established. At the same moment the flame detector is activated and closes the contact to the burner controller. This means that the flame detector is under a monitoring phase.

After the termination of the heat demand, all the components are disconnected except for the fan, which is now supplied by a power OFF delay timer (blue). This post-purge period lasts for 120 s.

At the end of the post-purge period, the burner turns off until the next heat demand.

Construction of the KB Series

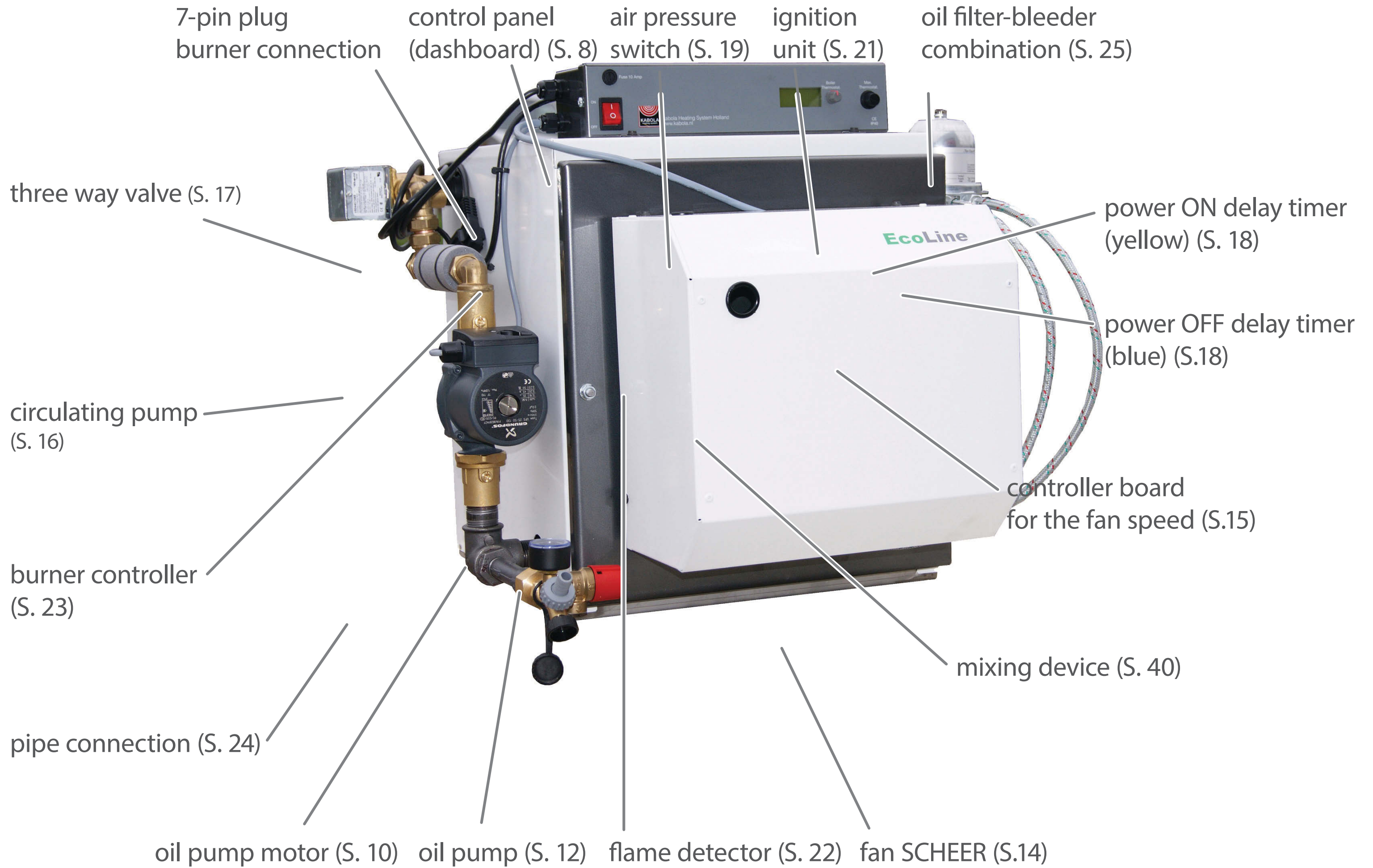

The standard KB-Series boilers (without further options) include the following components:

- Blue Frame Burner
- Dashboard
- Circulating pump
- Oil filter
- Room thermostat
- Pipe connection

Set the boiler temperature through the control panel. The control panel ensures the power supply to the burner, the circulating pump and the 3-way valve. Furthermore, a temperature sensor is also connected to the control panel and extends into the boiler thereby measuring the boiler water temperature.



control panel
Art.-Nr. 51-001

ATTENTION Only use genuine spare parts!

Replace the SCHEER oil pump motor only with a genuine spare part. This oil pump motor has a stator with a double enamelled wire, especially suitable for the marine sector.

Voltages below 200 V may lead to stoppage of the oil pump motor!



oil pump motor SCHEER
(previous model)

oil pump motor

Supply voltage	220 to 250 V AC (50/60 Hz)
Power	70 W
Speed	2760 min ⁻¹ at 50 Hz 3340 min ⁻¹ at 60 Hz
Operation capacitor	temperature resistant up to 100 °C (212 °F) 3 µF, 400 V AC

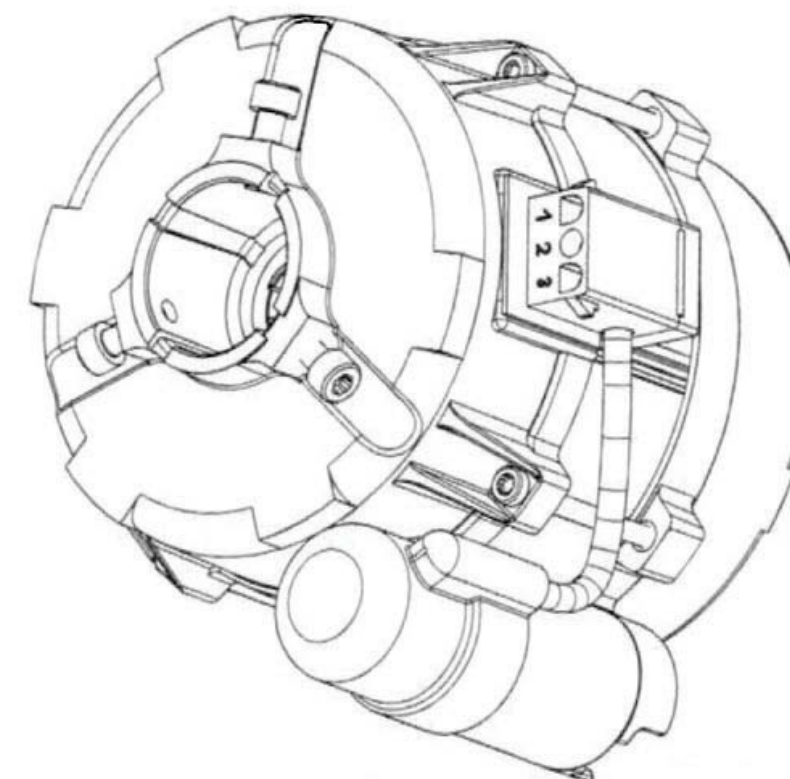

oil pump motor SCHEER
(current model)
Art.-Nr. 015138

ATTENTION

Check the capacitor at every maintenance. If the capacitance deviates by more than 5 % (lower than $2.85 \mu\text{F}$) the capacitor has to be replaced. A not adjusted capacitor could lead to further system failures (oil pump motor, oil pump), which might appear after some time.

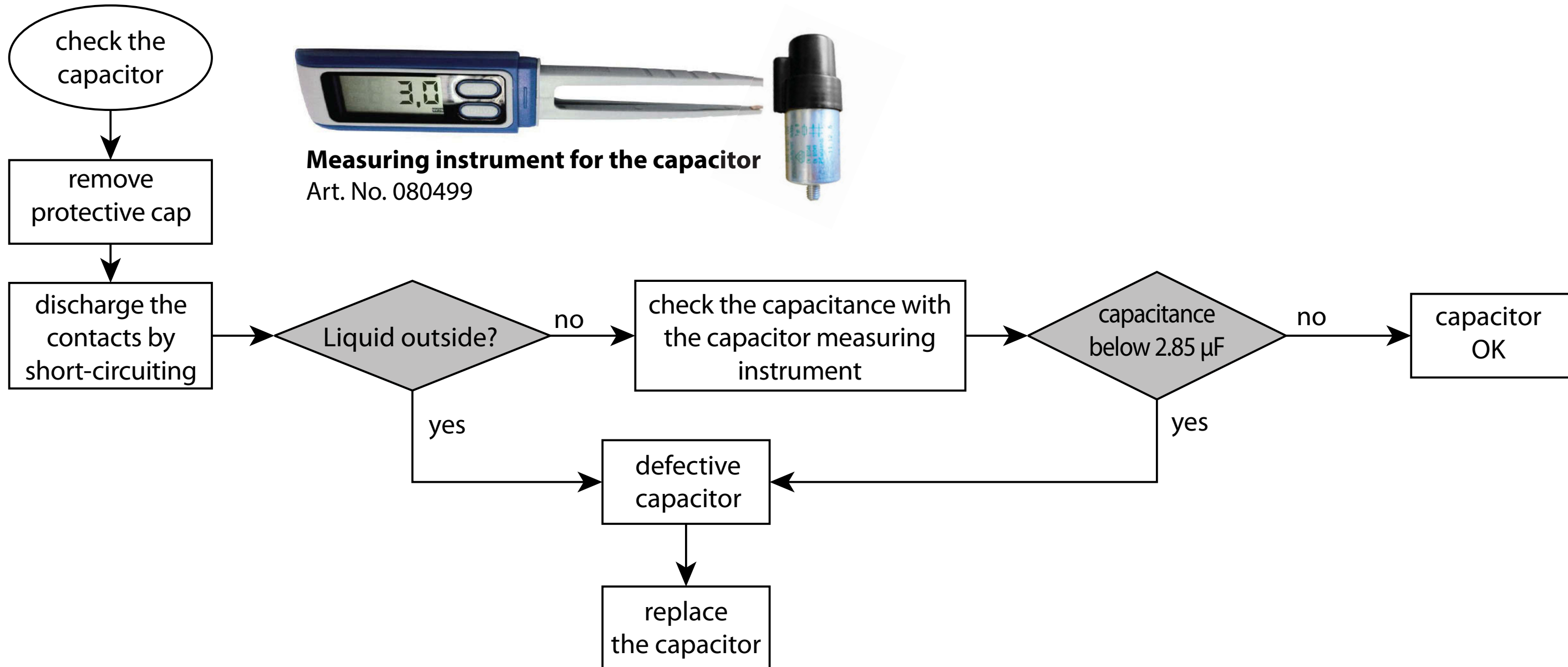

ATTENTION

Only use genuine spare parts!

Under no circumstances should you replace the SCHEER-oil pump by another SCHEER-oil pump type. The oil pump is specially configured for use in the KB-BE-burner. This particular oil pump provides full pressure at start-up, contrary to conventional pumps with progressively increasing pressure. Furthermore, this oil pump is compatible with up to 10% biodiesel.



oil pump SCHEER

Art. No. 011236

You can find the model-dependent oil pressure directly on the label on the burner.

oil pump

Pressure range	4 to 25 bar
Viscosity range	2 to 12 mm ² /s
Forward / return flow pressure	respectively max. 2 bar
Speed	max. 3600 min ⁻¹
Operating temperature	max. 60°C 32 to 140 °F

ATTENTION

Only use genuine spare parts!

Use only genuine SCHEER oil nozzles! A trouble-free operation can only be ensured through the use of genuine SCHEER nozzles. They are specially configured and tested in a flow range with only 5% tolerance.



oil nozzles SCHEER

	SCHEER oil nozzles	Art. No.
KB 20	0.18 - 80° SC	022276
KB 40	0.25 - 80° SC	022277
KB 45	0.40 - 60° SC	022368
KB 50	0.50 - 60° SC	022370
KB 75	0.65 - 60° SC	022373

The SCHEER fan is a powerful fan that is used in all models of the KB series. The fan through its centrifugal operation is essentially prohibiting dust and dirt particles to enter the airway.

The fan is in constant communication with the controller board. Through simple use of the controller board, the speed of the fan and thus an optimum combustion quality can be adjusted.



Centrifugal fan SCHEER
Art. No. 015112

Centrifugal fan

Supply voltage	230 V AC (50 Hz)
Power input	135 W (depending on the air flow)
Speed	max. 8.500 min ⁻¹ (depending on the air flow)
Air flow	max. 190 m ³ /h
Back pressure	max. 3.200 Pa and respectively 32 mbar

Service:

The fan through its centrifugal operation will remain clean; however it should be regularly inspected, especially when the installation area is very dirty or dusty.

To check the fan, disconnect it from power, remove the plastic cover and if there is any dust or dirt on the board remove it by blowing air on it.

The dust on the board works as isolation layer that blocks the heat, resulting in an overheating of the board.

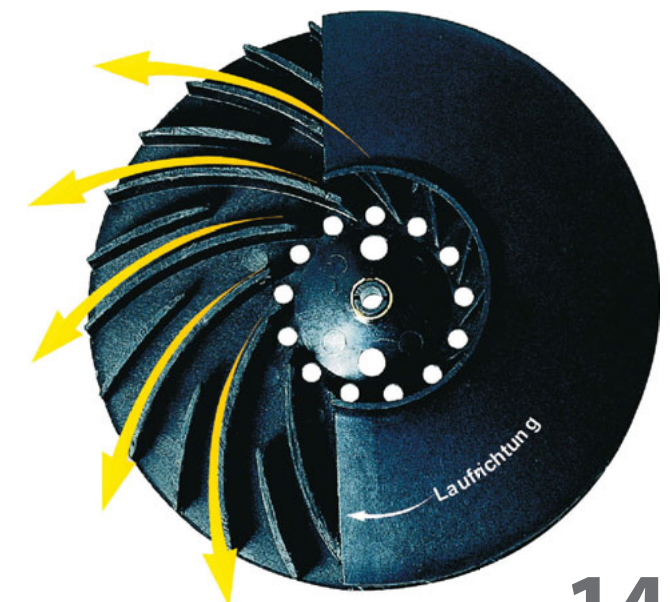

The SCHEER controller board allows for the adjustment of the fan speed, monitors the fan speed and prohibits the burner start-up when malfunctions or excessive deviations in fan speed are detected. The controller board is an intelligent system that adapts to the optimal fan speed for the burner start-up.



Controller board SCHEER

Controller board	Art. No.
KB 20	015374
KB 40	015376
KB 45	015377
KB 50	015378
KB 75	015379

The KB-BE circulating pump is responsible for the circulation of the boiler water and is mounted in the return flow of the boiler water.



High-efficiency circulating pump

(current model)

Art.-Nr. 9-I053



three-stage-circulating pump

(previous model)

circulating pump KB-BE

The KB-BE three way valve is provided with an electric drive. It is used for the two-point control as a mixer or distribution in the hot water system. The three way valve is controlled either by the boiler thermostat or by a room thermostat.

You can switch via a lever between automatic and manual mode (AUTO / MAN). Switch the lever to MAN when filling, venting and draining. Through the MAN position, the valve tappet is in the centre position. The water can then flow out to both outlets.

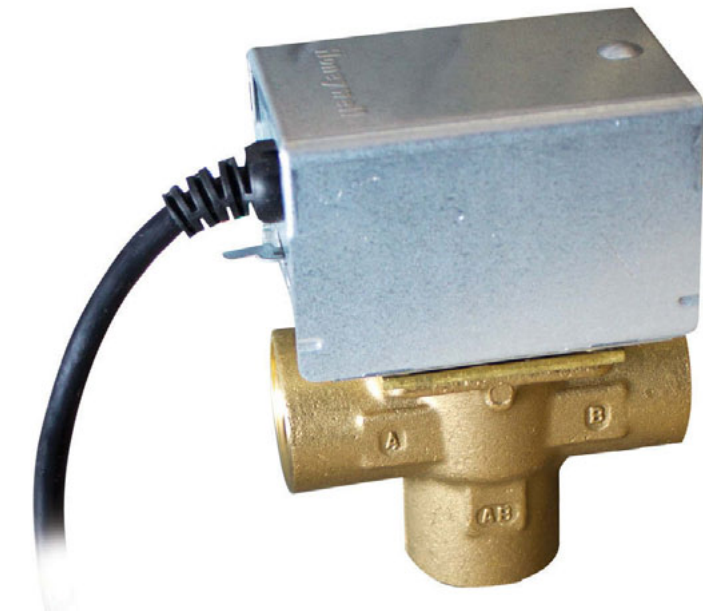

three way valve KB-BE

Art. No. 10-J004

power-on delay timer KB-BE

120 seconds

Art. No. 070555 (yellow)



The KB-BE **power-on delay** (marked by a **yellow dot**) delays the burner start-up for 120 seconds after a power interruption (switching over from on-board power to mains power).

power-off delay timer KB-BE

120 seconds

Art. No. 070553 (blue)



The KB-BE **power-off delay** (marked by a **blue dot**) enables at the end of the heat demand a post-purge period of the fan for 120 seconds.

The KB-BE air pressure switch controls the burner fan pressure and is connected to the solenoid valve of the oil pump.

The solenoid valve opens only when there is sufficient air pressure, so that the combustion process can start.

When the air pressure is insufficient, the air pressure switch prevents the leakage of oil into the combustion chamber.

Thus avoiding the contamination of the combustion chamber from oil and the possibility of explosions at the next start-up of the burner.



air pressure switch KB-BE

Art. No. 015180

Service:

Control the air pressure switch with the measuring instrument for the capacitor (Art. No. 080499), using the same settings as for the testing of the capacitor (no other setup is required).

The air pressure switch and measuring instrument can be coupled with the testing plug for the air pressure switch inspection (Art. No. 073017). The control of the air pressure switch can be performed also when the burner is in operation.



Measuring instrument for the capacitor
Art. No. 080499



Testing plug for the air pressure switch inspection
Art. No. 073017

The KB-BE ignition unit is an electronic ignition unit for intermittent ignition between 2 electrodes. Low weight and small dimensions, due to the high operating frequency, makes the ignition unit very suitable for modern compact burners.

Connections with a plug on the primary side and secondary side make installation and service quick and simple.

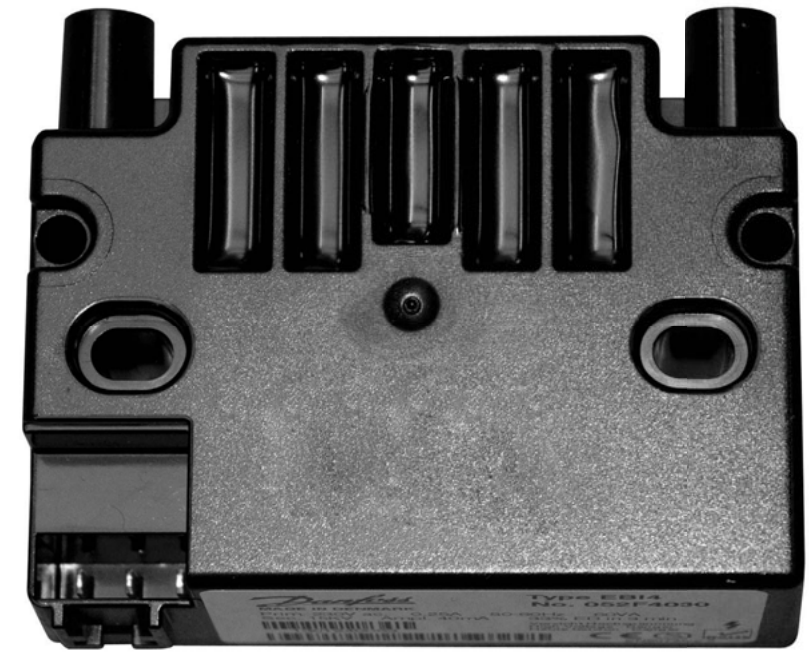

ignition Unit KB-BE

Art. No. 010276

The flame detector evaluates the flames based on their flicker frequency. The KB-BE flame detector is more efficient than a simple light flame detector.

Through the integrated frequency-interference suppression neither Light-resembling radiation (e.g. glowing surroundings) nor constant frequencies (e.g. fluorescent lamps) are recognized as a flame.

Unwanted influences of flame detection are thus avoided.

Operating status display:

LED off	Flame detector inactive
LED flashes	Safety testing is conducted, flame detector is active, no flame detected.
LED is lit	Safety testing is conducted, flame detector active, flame detected.

No adjustments are required for the SCHEER flame detector at initial commissioning or maintenance!



flame detector KB-BE
Art. No. 020064

The KB-BE burner controller takes over the operation/start-up and supervision of the burner. If a fault occurs during the start or burning process, the burner controller goes to a fault shutdown.

Fault	Response
Power failure	Restart
Loss of flame during operation	Restart
External light on burner startup	Fault shutdown
No flame after the safety period	Fault shutdown

Control program by fault shutdown

1. Triggers the fault shutdown in the burner controller
2. Immediate shutdown (<1 s) of all relevant for the oil supply components (solenoid valve, oil pump motor, oil preheater, igniter)
3. Interruption of the oil supply, and termination of the burning process
4. Fault indicator in shutdown reset button lights-up red

Low voltage detection

A separate circuit in the burner controller ensures that at voltages below 165 V AC the burner start-up is prevented or –without the release of oil– a fault shutdown is triggered.



burner controller KB-BE

Art. No. 020100

shown is a KB 20/7 kW

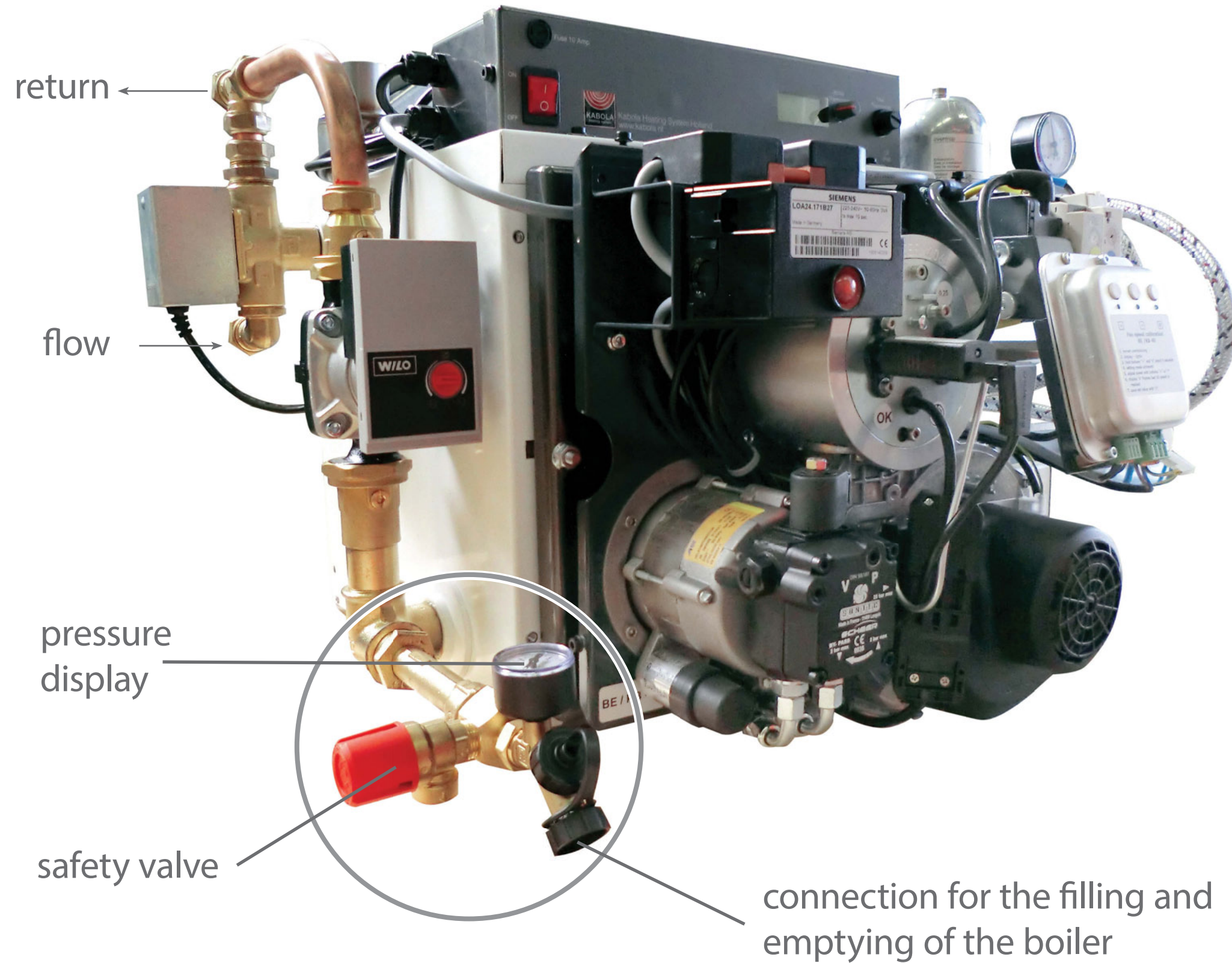

ACHTUNG

Make the installation of the KB-BE oil filter aerator combination according to the „oil supply“ on page XX.

The KB-BE oil filter-bleeder combination cleans the oil and keeps it air-free. The trouble-free operation of the burner is only achieved with clean, air-free oil.

Use only **oil filter and bleeder made of metal!** Plastic parts are not permitted on maritime purposes for fire safety reasons.

The KB-Series are delivered with the oil filter-bleeder combination made of metal, as shown in the figure. The oil filter contains an ultra-fine filter insert. The oil bleeder vents the oil automatically.

If you use any other oil filter or bleeder, please note the following minimum requirements:

Oil filter

- completely made of metal
- suitable for single pipe systems
- an ultra-fine filter insert



oil filter-bleeder combination made of metal
Art. No. 040513

The KB-Series are delivered with an oil filter-bleeder combination made of metal, in order to fulfil the fire safety regulations of the maritime sector. The allocated holder for the combination is located on the right side of the boiler. If because of space issues you can not attach the combination to the holder, you can also position the combination otherwise.

However, you should mount the combination **at higher than the oil pump!** Otherwise, the automatic bleeder will not work properly, the oil will not be air-free and this will result to a burner malfunction.

Use for the **oil line between the oil tank and the oil filter,**

only the following lines:

- Steel pipe or pre-oxidised copper pipe. SCHEER recommends a precision steel pipe (Ermeto-type fitting). For copper pipes, a support sleeve (made of brass) is mandatory.
- Inner diameter 6 mm
- Outer diameter 8 mm

If you use a longer line, (should be larger diameter line) it may result in accumulation of air in the oil line, which can hinder the flow of oil or lead to burner malfunctions.

A smaller (should be smaller diameter line) line can be quickly damaged by external influences.

You should not use smaller line than the above mentioned.

The oil filter-bleeder combination mounted on the allocated holder, on the side of the boiler.

ATTENTION

- Automatic air vent must always be mounted above the level of the oil pump.
- Min 50% of the length of hose should be routed ascending.

Don't mix up flow and return!

The oil filter-bleeder combination mounted on the allocated holder, on the side of the boiler.

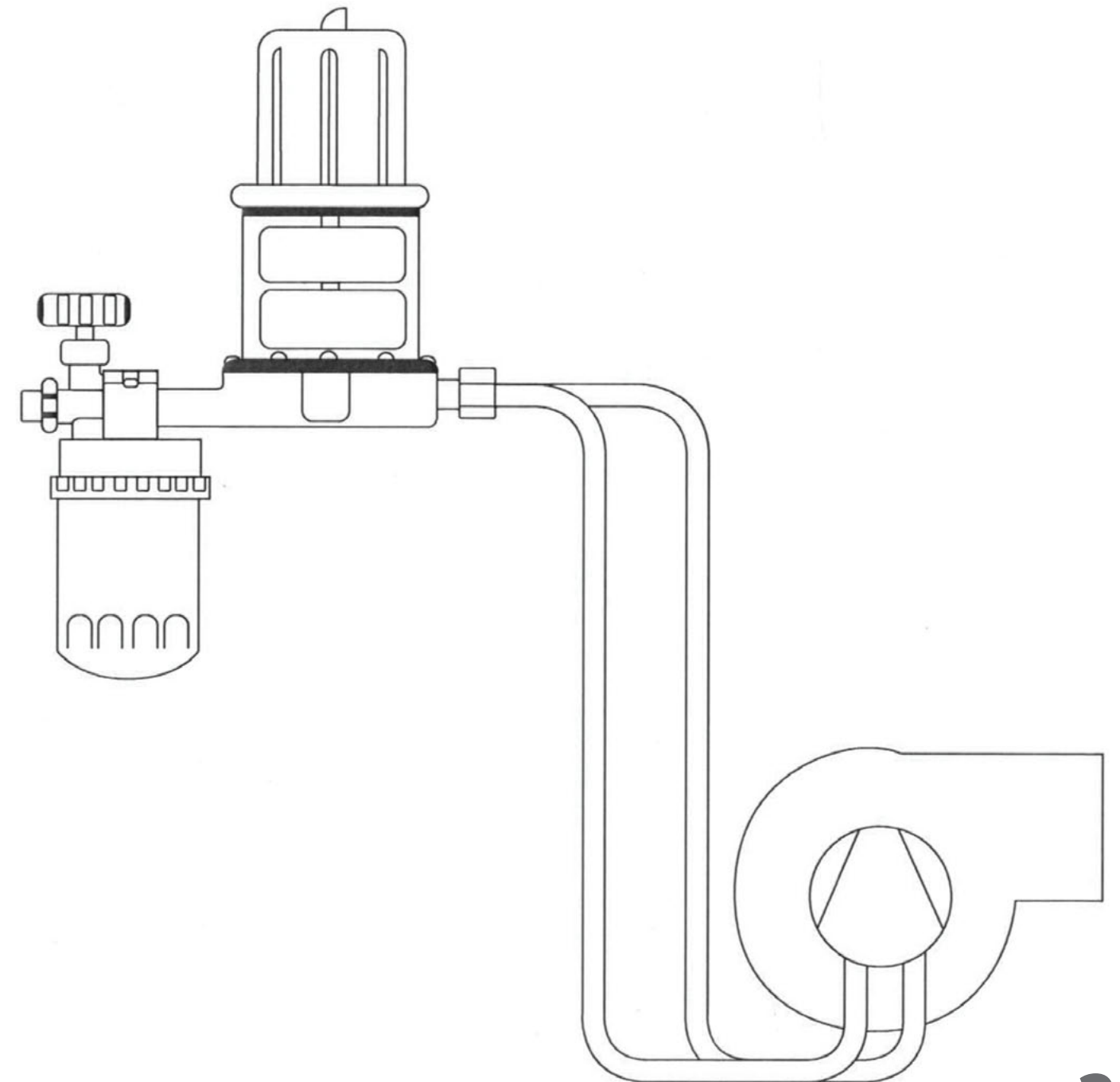

ATTENTION

- The burner achieves **soot-free combustion** only with **sufficient combustion air**.
- Ensure **adequate air supply**.

There are two possibilities for the supply of combustion air:

- **external air supply through an air ventilation** shaft when large air consuming devices (eg main engine, generators) are installed in the same room as the KB-Series.
- **air supply dependent on ambient air**, when there are no other air consuming devices in the installation room.

For ambient air dependent air supply, select a diameter for the room ventilation of minimum 2.5 times the diameter of the exhaust pipe

KB 20, KB 40, KB 45	KB 50, KB 75
50 mm exhaust pipe diameter	80 mm exhaust pipe diameter
125 mm room ventilation diameter	200 mm room ventilation diameter

Note that other air consuming devices in the installation room may require a larger diameter for the room ventilation.

We recommend an external air supply, in order to achieve sufficient air supply to the burner at all times. Only with sufficient combustion air does the burner reach the best exhaust emissions, soot-free combustion and highest efficiency.

The components of the external air supply from the air ventilation shaft are in the following order:

1. Connector for pipe at the air ventilation shaft
2. Pipe (rigid or flexible), minimum diameter 50 mm
3. Transition piece for any diameter compensation from flexible pipe to inlet manifold
4. Inlet manifold (connected with the centrifugal fan) with a 50 mm diameter for the pipe connection

Connect the individual components with matching hose clamps.

! WARNING

- **Risk of burns!** The **exhaust gas** and accordingly the exhaust system is heated up to **220 °C (428 °F)**! Contact with skin can cause severe burns. Insulate throughout the exhaust system with heat resistant material, in areas reachable by body parts.
- **Danger of explosion!** If you include an **blocking device** in the exhaust system, it is then necessary to use a **contact switch** that is connected to the burner.

ATTENTION Risk of corrosion!

- The entire **exhaust system** must be made of **stainless steel** in order to withstand the high exhaust gas temperatures of up to 220 °C (428 °F) and corrosive ingredients of the exhaust gas.
- **Outdoors** the exhaust gas routing must be **double-walled**. Otherwise, condensate may form due to the rapid cooling.

HINT: Condensate may accumulate in the exhaust system when the exhaust gas temperature is low.

Emission-related information for the KB-Series		KB 20	KB 40	KB 45	KB 50	KB 75
Exhaust temperature	°C	170 - 220	150 - 210	145 - 205	145 - 200	140 - 190
	°F	338 - 428	302 - 410	293 - 401	293 - 392	284 - 374
Exhaust pipe-Ø	mm	Ø 50			Ø 80	
Muffler recommended		no			yes	

Maintenance KABOLA-KB-Series

Kabola / SCHEER Blue Efficiency[®] burners are TÜV-certified as completely soot-free. There is no additional thermal insulation on the walls of the burner. For other than blue burners, the exhaust temperature increases with about 40 degrees with every millimeter of soot-film on the boiler's interior wall, leading to a massive reduction in energy efficiency.

1.	Condensate collector	Annual visual inspection. When there is condensate present, the exhaust gas routing should be repaired.
2.	Boiler cleaning	Annual visual inspection. To be carried out with with the suitable cleaning set.
3.	Nozzles	Annual visual inspection. If necessary replace using genuine parts. Recommended replacement period: every two years.
4.	Ignition electrodes	Annual visual inspection. If necessary replace using genuine parts. Recommended replacement period: every three years.
5.	Flame tube	Annual visual inspection. If necessary replace using genuine parts. Recommended replacement period: every four years.
6.	Door gasket: Cord and Positioning	Visual inspection every three years for the cord and door positioning, if necessary re-tighten. Recommended replacement period: when necessary.
7.	Exhaust measurement	Annual.
8.	Oil filter replacement	Recommended replacement period: every two years. If the underpressure manometer indicates underpressure greater than -0.3 bar (e.c. -0,35 bar) than replace the filter
9.	Fan cleaning	Recommended inspection period: every three years. If dirty operation environment, than shorter.

Prepare the KB-Series for the **maintenance** as follows:

1. If the burner is in operation, cancel the heat demand.
2. Wait for the post-purge period with a 120 s duration.
3. Turn off the KB-Series with the main switch on the control panel.
4. Disconnect the plug from the 7-pin connector to the burner. The power supply of the burner is now interrupted.
5. Disconnect the plug of the control panel from the power outlet. The power supply of the boiler is now interrupted.
6. Dismantle the burner including the burner door from the boiler.
7. The steps for cleaning the boiler and for the burner maintenance, are shown in the previous sections.
8. After the cleaning, mount again the burner to the boiler.

ATTENTION

- It is essential to adjust the fan pressure during the initial commissioning!
 - The default fan pressure is only an initial setting.
 - **The right CO₂ level is essential.** You can find the required CO₂ value on the burner.
1. Turn the burner on at the main switch of the control panel.
 2. After a preheating time of the oil preheater, the burner goes into operation.
 3. Turn the **burner on and off, 3 times in a row.** Always include the post-purge period of 120 s! By switching ON and OFF, any air is removed from the nozzle head.
The air can lead to fluctuations in throughput and thus distort the measurement result.
 4. Wait until the boiler has reached a **minimum temperature of 60 °C (140 °F).** The boiler is then in steady condition.
 5. Connect the **flue gas analyser** to the measurement port in the exhaust system behind the boiler.

6. Adjust the fan speed using the fan controller board:
 - a. Hold down the + and S buttons for approximately 5 s
 - b. Indicator + flashes and indicator S illuminates
 - c. Adjustment mode can be now accessed
 - d. Adjust the fan speed by pressing + or -. Pay attention to the measured CO₂ value. The required CO₂ level is indicated on the burner.
 - e. Indicator S flashes fast until the speed adjustment is completed.
 - f. Save the set value by pressing the S key.
 - g. Indicator + illuminates, operating setting completed

 7. Close carefully the measurement port after the analysis.
- The adjustment of the fan speed and thereby the adjustment of the CO₂ value is also described on the controller board.**



Controller board, with the description of the fan speed adjustment

OPTIONAL: water heating via plate heat exchanger

Via the plate heat exchanger, the water in the boiler heats the cold fresh water, which is then available as heated water.

Water heating via a plate heat exchanger can be offered as an option for **models KB 40, KB 45, KB 50 and KB 75.**

These models have the additional Combi e.g. **KB 40 Combi.**



The **underpressure manometer** shows the underpressure in the supply flow to the oil pump.

The system is running optimally in the underpressure range from 0.0 to -0.3 bar. A filter change **is recommended for values between -0.3 and -0.5 bar**, while even greater underpressure may cause malfunctions and an increased pump wear should be expected.

Underpressure manometer
Art. No. 040126



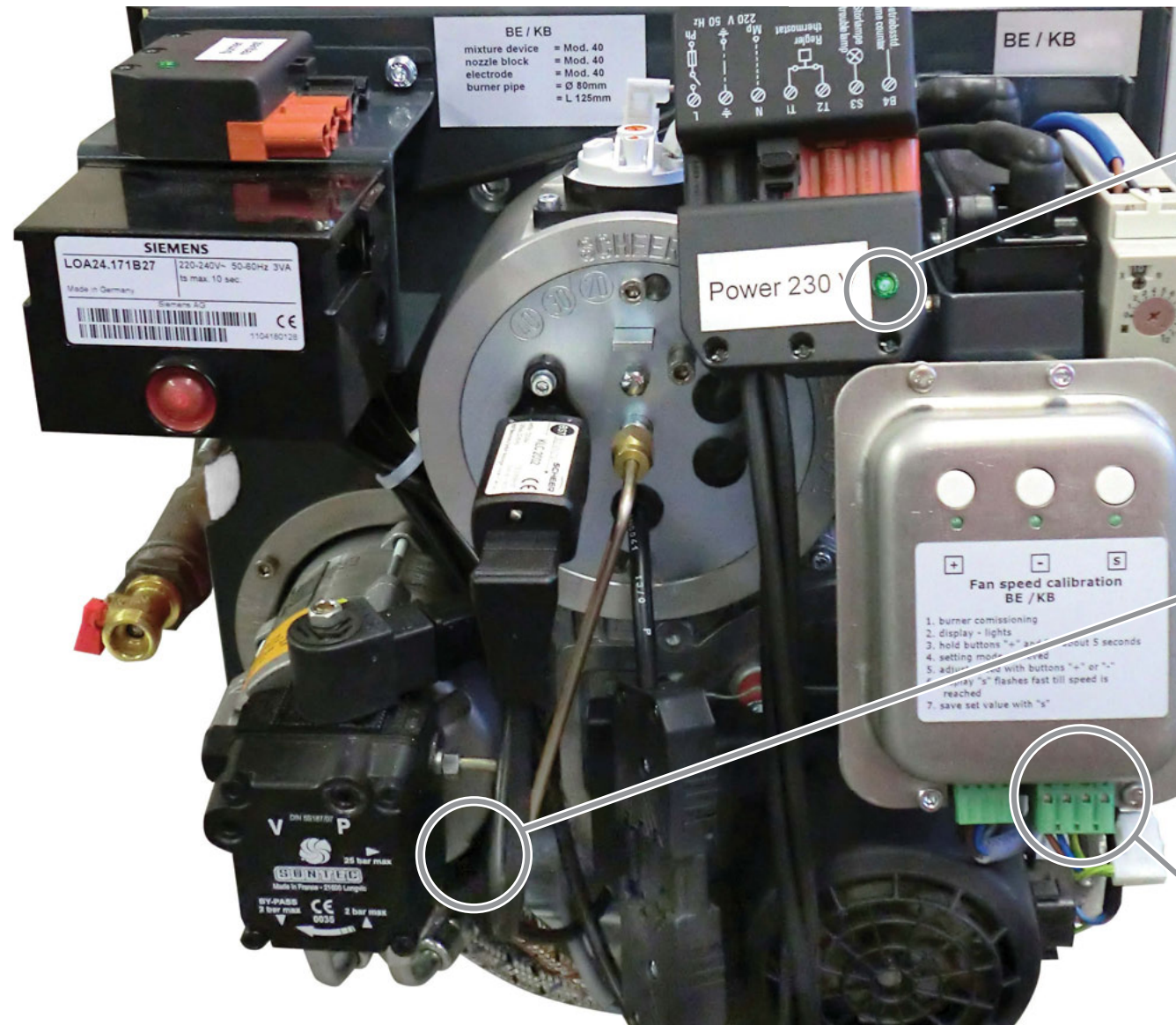

1 With the MULTI-service plug connector connected, the indicator light indicates whether a correct phase polarity is applied to the burner.

2 With the direct connection to the oil pump motor or fan motor, you can check their function and listen for sounds that indicate faulty bearings.

3 In case the oil supply is disrupted (e.g. tank is empty), it can be detected and put it back into service through the direct access to the oil pump motor. Only allowed for small oil line lengths.



Service plug connector for the fan and controller board
Art.-Nr. 73010

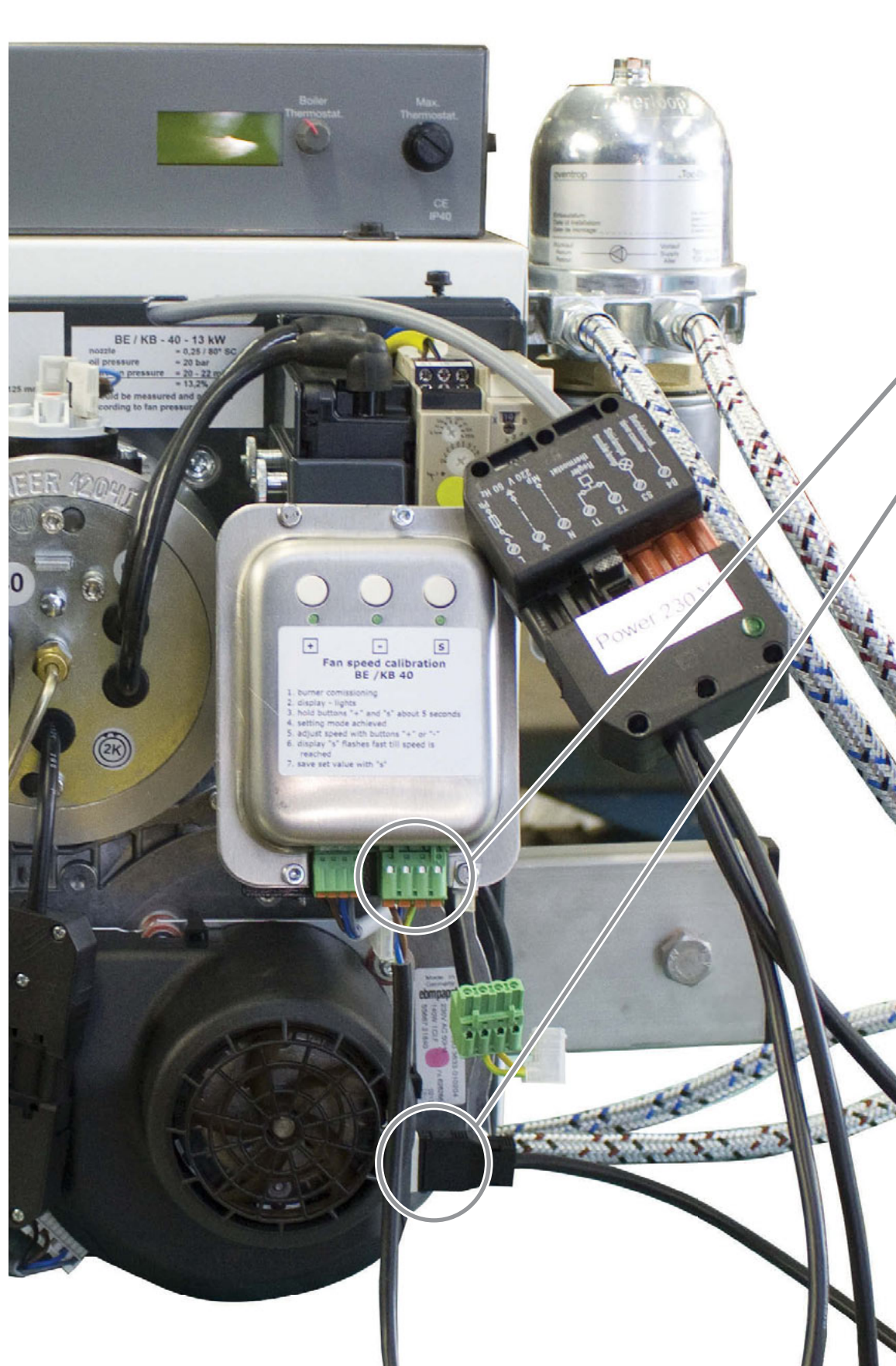

4

If the fan controller prohibits the burner start-up due to a defect or major deviations (see performance data on the burner), then the set values can be corrected through the direct supply of the fan motor and the controller board or a new controller board (regardless of the burner output).

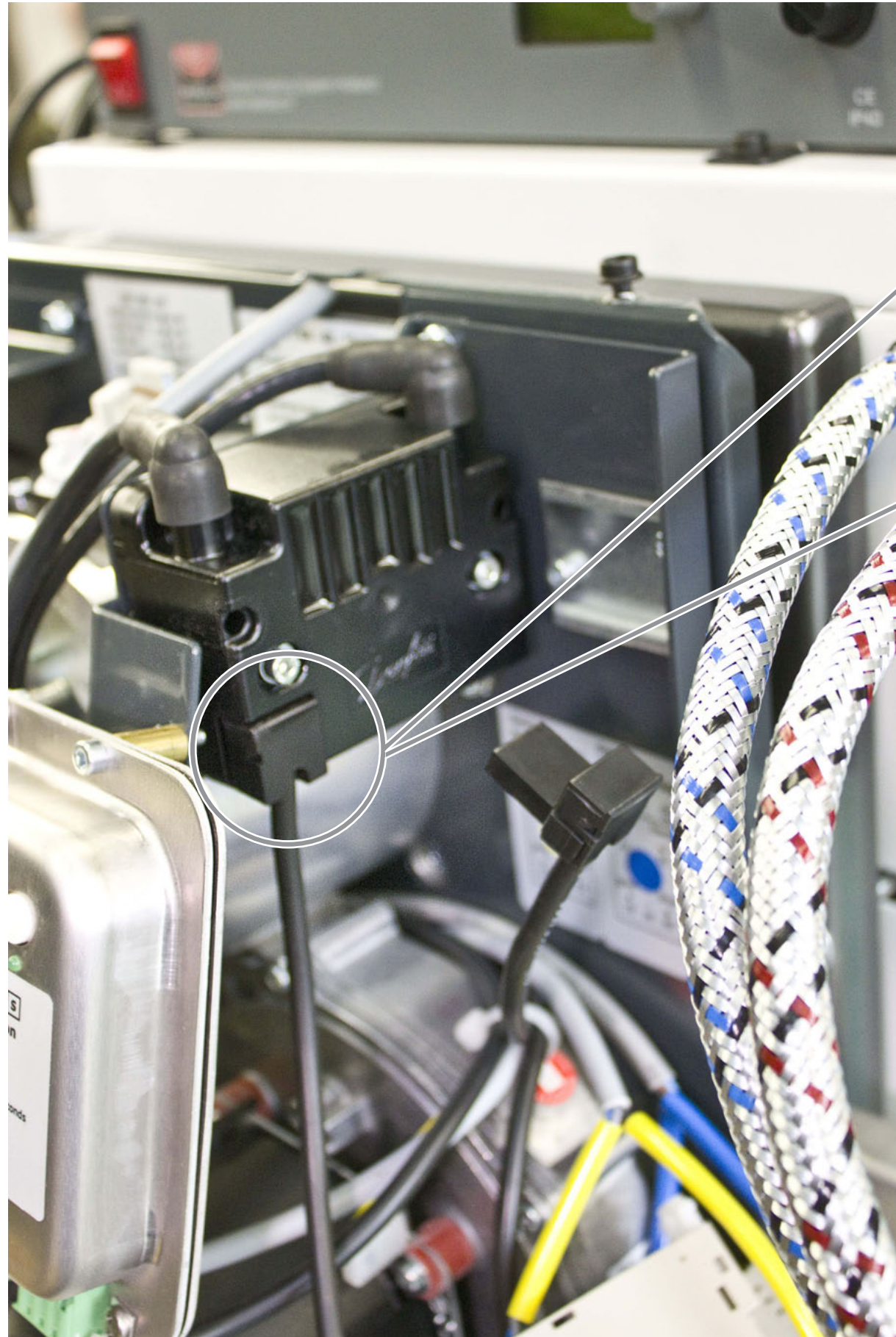

- 5 Through the direct control of the ignition unit the function of the transformer can be made audible.
- 6 With the removal of the mixing device and the direct connection of the ignition cable to the transformer, the ignition spark can be made visible..

ATTENTION Risk of corrosion!

Do not use for cleaning any aggressive liquids such as thinner or gasoline! These attack the material and can lead to corrosion.

A well-adjusted burner has a soot-free combustion. Because of that, the effort of cleaning the boiler is low.

A **thin, clear layer** can be formed in the combustion chamber. This is a sign of a good combustion. **Do not remove this layer mechanically**, because it acts as a preservative for the combustion chamber.

After you have removed the burner from the boiler, follow the steps for the cleaning of the boiler. Pay attention to an adequate ventilation!

1. Remove the insulation on the front side of the boiler.
2. Brush the tubes with the plastic brush. Do not use a metal brush because you will produce steel fragments that will create corrosion in the exhaust system.
3. Sweep the combustion chamber with the cleaning brush.
4. Sweep the front side of the boiler with the cleaning brush or a hand brush.
5. Vacuum any loose dust with a vacuum cleaner.
6. Reattach the insulation.
7. Mount the burner to the boiler.



Cleaning kit (plastic brush, cleaning brush)

Remove the mixing cartridge:

1. Remove the plug from the flame detector and remove the ignition cable from the ignition unit. The mixing cartridge is no longer connected to the rest of the burner.
2. Loosen the mounting screws of the mixing cartridge. Since this is a bayonet mount, you do not need to completely remove the screws.
3. Turn the mixing cartridge slightly to the left.
4. Drag the mixing cartridge towards you and out from the burner.

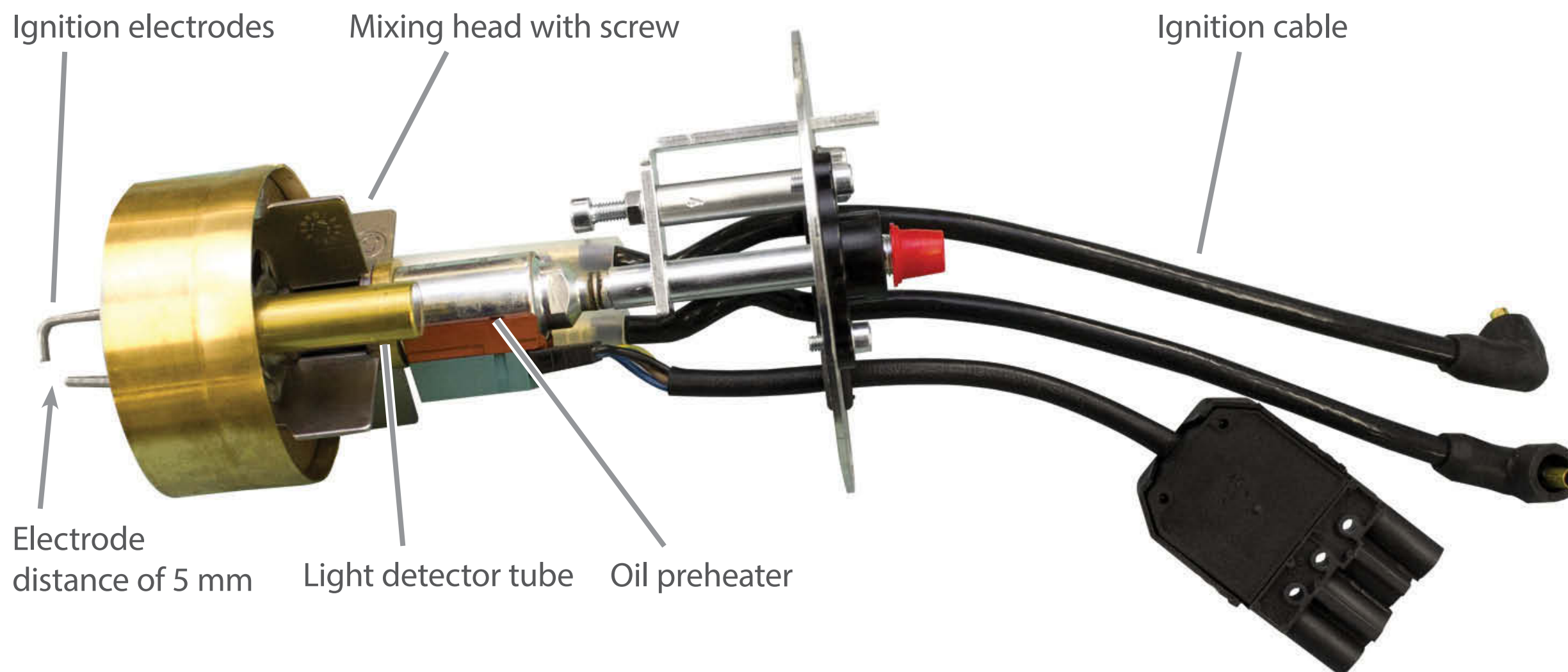

Mixing cartridge	Art. No.
KB 20	015380
KB 40	015382
KB 45	015383
KB 50	015384
KB 75	015385

- 1.** Control the **light detector tube**. The flame detector monitors the flame through the light detector tube. Clean the glass surface of light detector tube, optionally with burner cleaner and a soft cloth.
- 2.** Control the **ignition electrodes**. If these are burned or not properly placed in the holder, they should be replaced with genuine SCHEER ignition electrodes.
- 3.** Check the distance of the **ignition electrodes**. The **distance between the ignition electrodes must be 5 mm**. If the distance is greater or smaller than the specified, they should be replaced with genuine SCHEER ignition electrodes. Do not turn the ignition electrodes! The electrodes could break.
- 4.** Control the **oil nozzle**. If the nozzle is damaged or if deposits are present, it must be replaced. The nozzle replacement is described in the next section
- 5.** Proceed with the installation of the mixing cartridge in the reverse order of its removal.

ATTENTION Only use genuine spare parts!

- The oil nozzles are specially designed for the KB burner. Therefore, only SCHEER oil nozzles are allowed.
- You can recognize the SCHEER oil nozzles from the designation SC. If you use other nozzles, it may result burner malfunction or burner failure.

For the right oil nozzle please refer to the opposite table.

Take the oil nozzle from the packaging only directly before the insertion! The nozzle may otherwise be damaged.

	SCHEER oil nozzles	Art. No.
KB 20	0.18 - 80° SC	022276
KB 40	0.25 - 80° SC	022277
KB 45	0.40 - 60° SC	022368
KB 50	0.50 - 60° SC	022370
KB 75	0.65 - 60° SC	022373

Electrode
distance
of 5 mm



Air bush and oil
nozzle in the same
level!

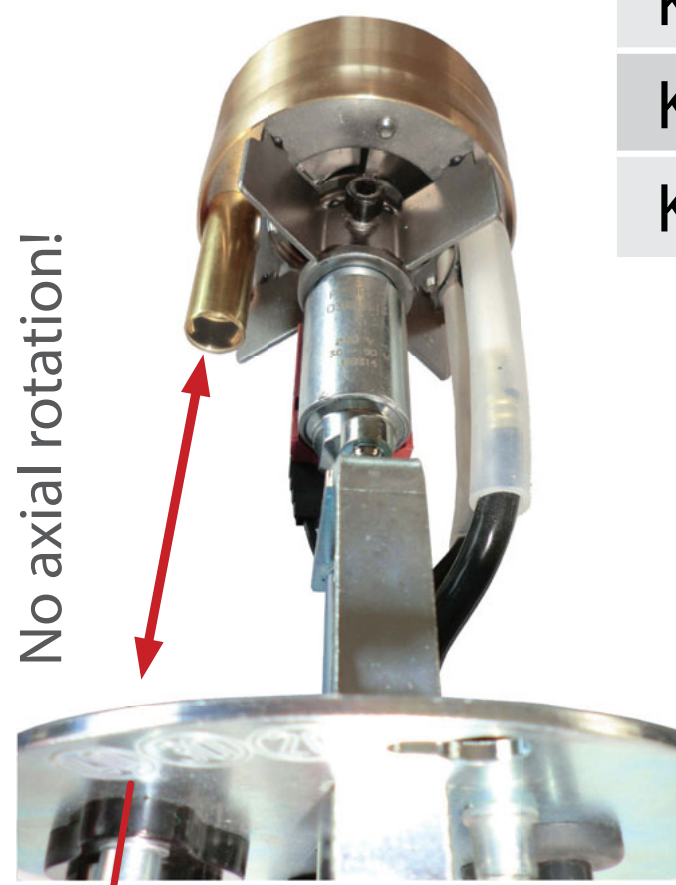

No axial rotation!

Flame detector

Replace the oil nozzles in the following steps:

1. Loosen the screw of the mixing head. Pull the mixing head from the nozzle holder. The nozzle is now exposed.
2. Unscrew the old oil nozzles with a box-end wrench. If necessary, use a second box-end wrench to stabilise the nozzle holder. Do not use an open-end wrench or similar, as the oil nozzles or the nozzle holder could be damaged by the unequal stress.
3. Take the new nozzle from the packaging. Hold the oil nozzles only at the sides of the hexagon, so that they are not damaged.
4. Turn the new nozzle hand-tight with a box-end wrench. If necessary, secure the nozzle holder with a second box-end wrench. If the nozzle is tightened too hard, it may jam / tilt in the nozzle holder during the burner operation and may no longer be released without damage. In that case, a new mixing cartridge is required.
5. Mount the mixing head on the nozzle holder. The oil nozzles and the air bush must be in the same level. Do not use metal for placing! The metal may damage the nozzle. **The oil nozzles must not extend from the air bush.**
6. Make sure that the light detector tube and the flame detector are in a line. In case of an axial rotation there can be no flame detection and this results in a malfunction shut down.
7. Turn the screws of the the mixing head hand-tight. If you tighten the screws too tight, the nozzle holder deforms and the exact positioning of the mixing head is no longer possible.
8. Mount the mixing cartridge in the reverse order as the one described in the section „Cleaning the boiler“.



Measuring instrument for the capacitor

Art. No. 080499



Service plug connector for the fan and controller board

Art. No. 073010



Service plug connector for engine / oil pump / solenoid valve

Art. No. 073016



Service plug connector for oil preheater
 Art. No 073013



Service Help - oil pressure line
 Art. No 073025

collection vessel for oil

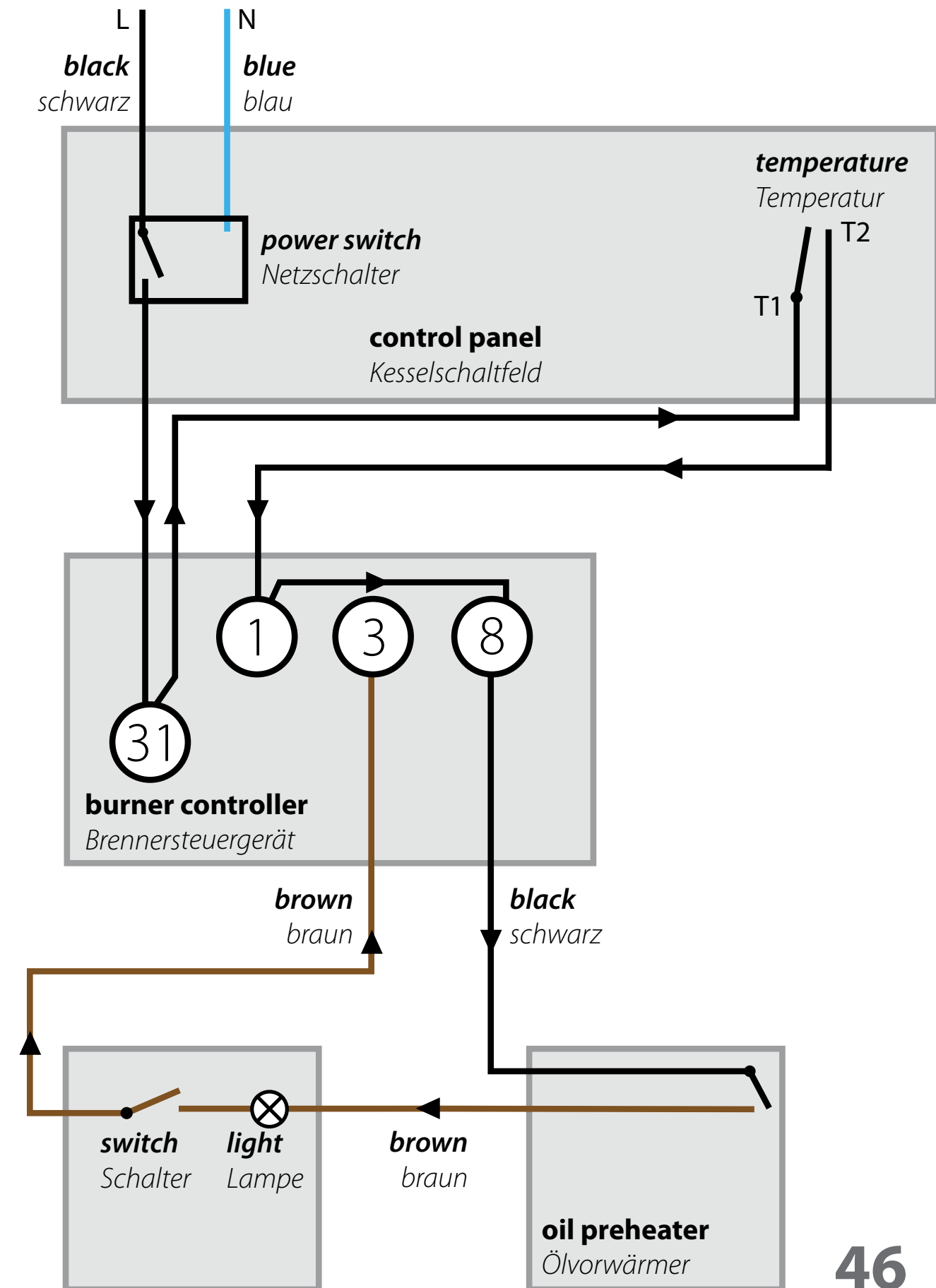

1. disconnect the power supply

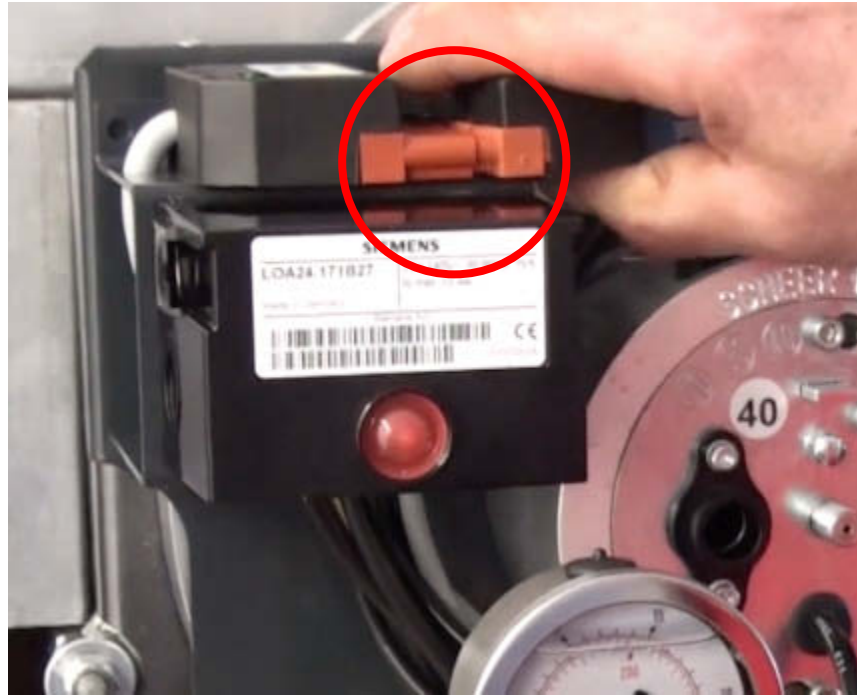

2. disconnect the flame detector



3. disconnect the oil line



4. connect the Service Help



5. disconnect the plug from the oil pump motor



6. connect the plug from the service-plug with the oil pump motor



7. disconnect the plug from the oilpump and connect the plug from the service plug



8. connect the service plug with the power supply



9. turn on the dashboard



10. turn „ON“ at the service plug



12. the filter fills up



11. oil line fills

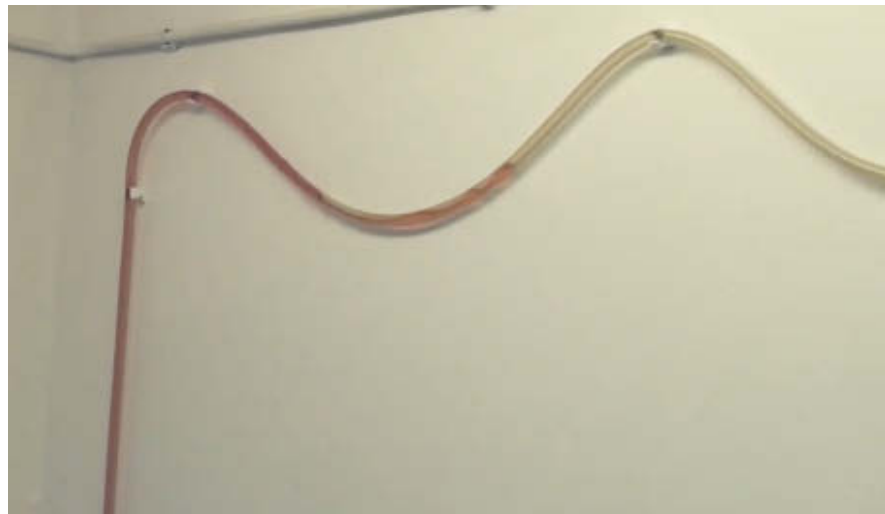

13. the air escapes through the Service Help



14. To stop the vent turn „OFF“ at the service plug.
The oil is passed via the return flow.



Jumper plug for air pressure switch

Art. No. 019676

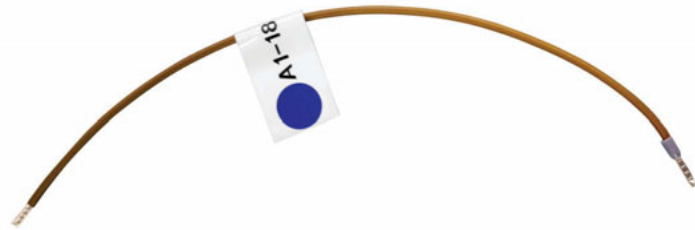

Cable bridge power-off delay timer Contact A1 - 18

Art. No. 073015

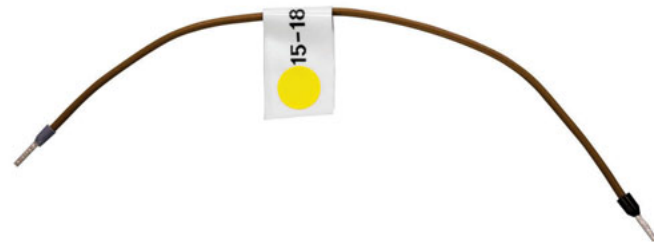

Cable bridge power-on delay timer Contact 15 - 18

Art. No. 073018



Flexible test tube for the oil supply system

Art. No. 080498



Testing plug for the air pressure switch inspection

Art. No. 073017



Jumper plug for the oil preheater

Art. No. 019675

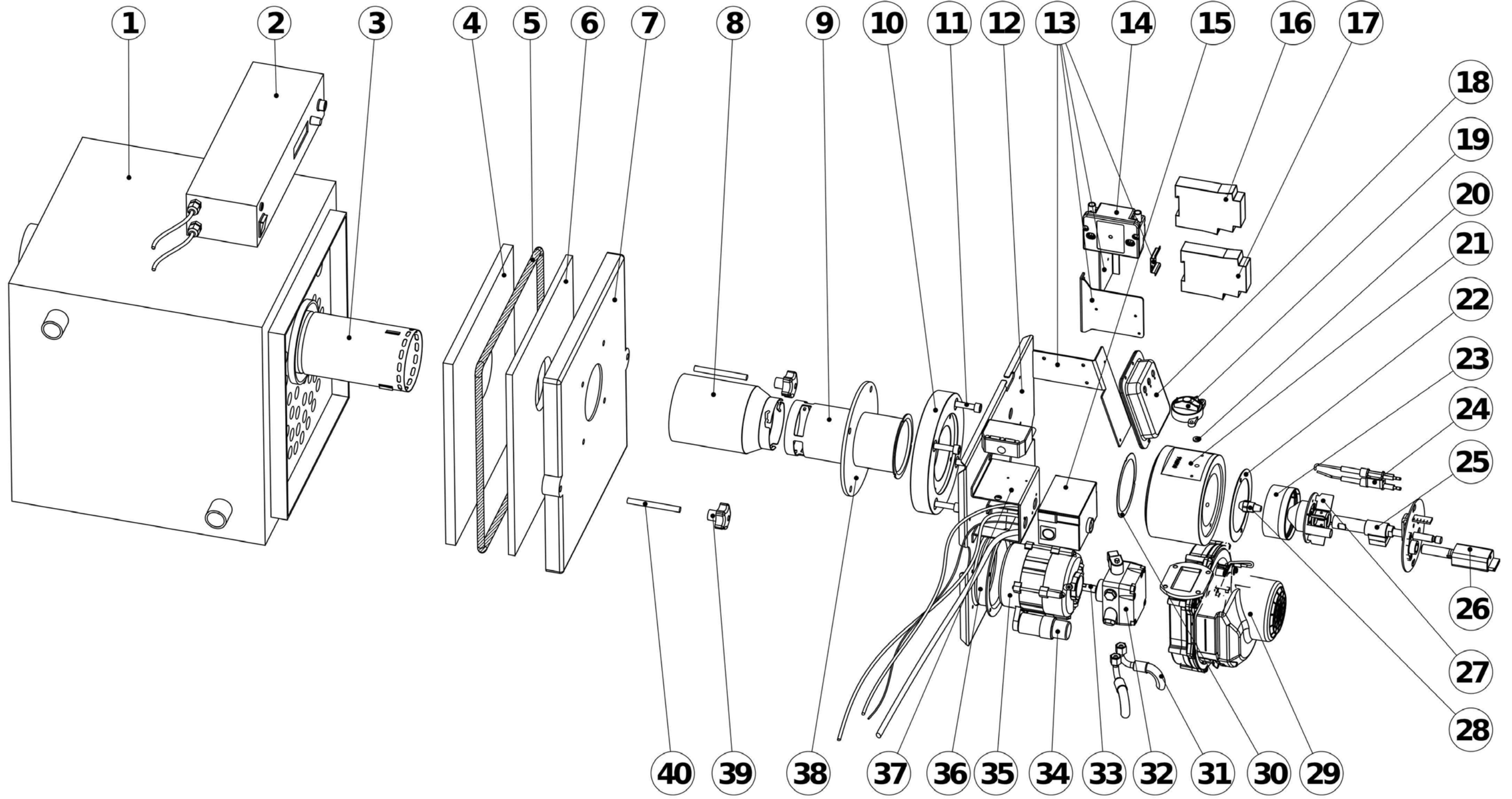

No.	Description	KB 20	KB 40	KB 45	KB 50	KB 75
1	Boiler KB complete <i>KB-Kessel komplett</i>	077980	077984	077987	077990	077993
2	Control panel <i>Schaltfeld</i>	51-001				
3	Combustion chamber insert <i>Brennkammereinsatz</i>	NN			-	
4	Boiler insulation <i>Kesselsolierung</i>	44-004	46-005	47-005		49-005
5	Door gasket cord <i>Kesseltürkordel</i>	13-M084				
6	Door insulation for the boiler door gasket <i>Türisolierung Kesseltürstein</i>	44-003	46-004	47-004		49-004
7	Door <i>Tür</i>	-				
8	Flame tube <i>Flammenrohr</i>	015110			015114	
9	Adapter pipe Ø 80 x 1.5 x 109 mm <i>Adapterrohr Ø 80 x 1,5 x 109 mm</i>	015179				
10	Ring adaptor <i>Ringadapter</i>	015967				
11	Fixing screws for the burner including washers <i>Befestigungsschrauben Brenner inkl. Scheiben</i>	015365				
12	Support plate for burner components <i>Komponenten Trageblech</i>	015958				
13	Supporting plates for components for 17, 18, 34 <i>Trägerplatten für 17, 18, 34</i>	015367				
14	Ignition Unit <i>Zündtrafo</i>	010276				
15	Burner controller <i>Steuergerät</i>	020100				
16	Power-on delay timer (yellow) <i>Einschaltverzögerungsrelais (gelb)</i>	070555				

No.	Description	KB 20	KB 40	KB 45	KB 50	KB 75
17	Power-off delay timer (blue) <i>Ausschaltverzögerungsrelais (blau)</i>	070553				
18	Controller board <i>Regelplatine für Gebläse</i>	015374	015376	015377	015378	015379
19	Air pressure switch <i>Luftdruckwächter</i>	015180				
20	Ring seal for the air pressure switch <i>Ring für Luftdruckwächter</i>	015181				
21	Burner block module (including 16 + 22) <i>Brennerblockmodul (16 + 22 inkl.)</i>	015966				
22	Seal for nozzle holder holding plate <i>Dichtung Düsenstockhalteplatte</i>	015172				
23	Dosage ring <i>Dosiering</i>	015413				
24	Ignition electrode set with holder <i>Zündelectroden-Satz mit Halter</i>	015357			015358	
25	Nozzle holder complete set <i>Düsenstock komplett</i>	015471	015472	015473	015474	
26	Flame detector <i>Flammenwächter</i>	020064				
27	mixing cartridge (including 23 + 24) <i>Mischpatrone (23 + 24 inkl.)</i>	015380	015382	015383	015384	015385
28	SCHEER Oil nozzles <i>Öldüse</i>	022276	022277	022368	022370	022373
29	Centrifugal fan (two-stage) <i>Radialgebläse (zweistufig)</i>	015112				
30	Ring seal for the adapter pipe <i>Ringdichtung Adapterrohr</i>	015170				

No.	Description	KB 20	KB 40	KB 45	KB 50	KB 75
31	Oil line (2 pieces) <i>Ölschlauch (2 Stück)</i>			041411		
32	Oil pump <i>Ölpumpe</i>			011236		
33	Motor clutch <i>Motorkupplung</i>			010292		
34	Capacitor 3µF /100°C <i>Kondensator 3 µF /100°C</i>			010294		
35	Oil pump motor 70 Watt <i>Ölpumpenmotor 70 Watt</i>			015138		
36	Support plate for the oil pump motor <i>Ölpumpenmotorträger</i>			015366		
37	Distribution board Kabola (single-stage) <i>E-Verteiler Kabola einstufig</i>			015968		
38	Burner flange seal <i>Brennerflanschdichtung</i>			031430		
39	Door rotary knob KB-Series <i>Tüрдrehknauf KB-Serie</i>			-		
40	Bolts <i>Bolzen</i>			-		
41	Circulating pump <i>Umwälzpumpe</i>			9-1053		
42	Three way valve <i>3-Wege-Ventil</i>			10-J004		

If you want to exchange your existing Kabola HR-burner, then the following burners are suitable:

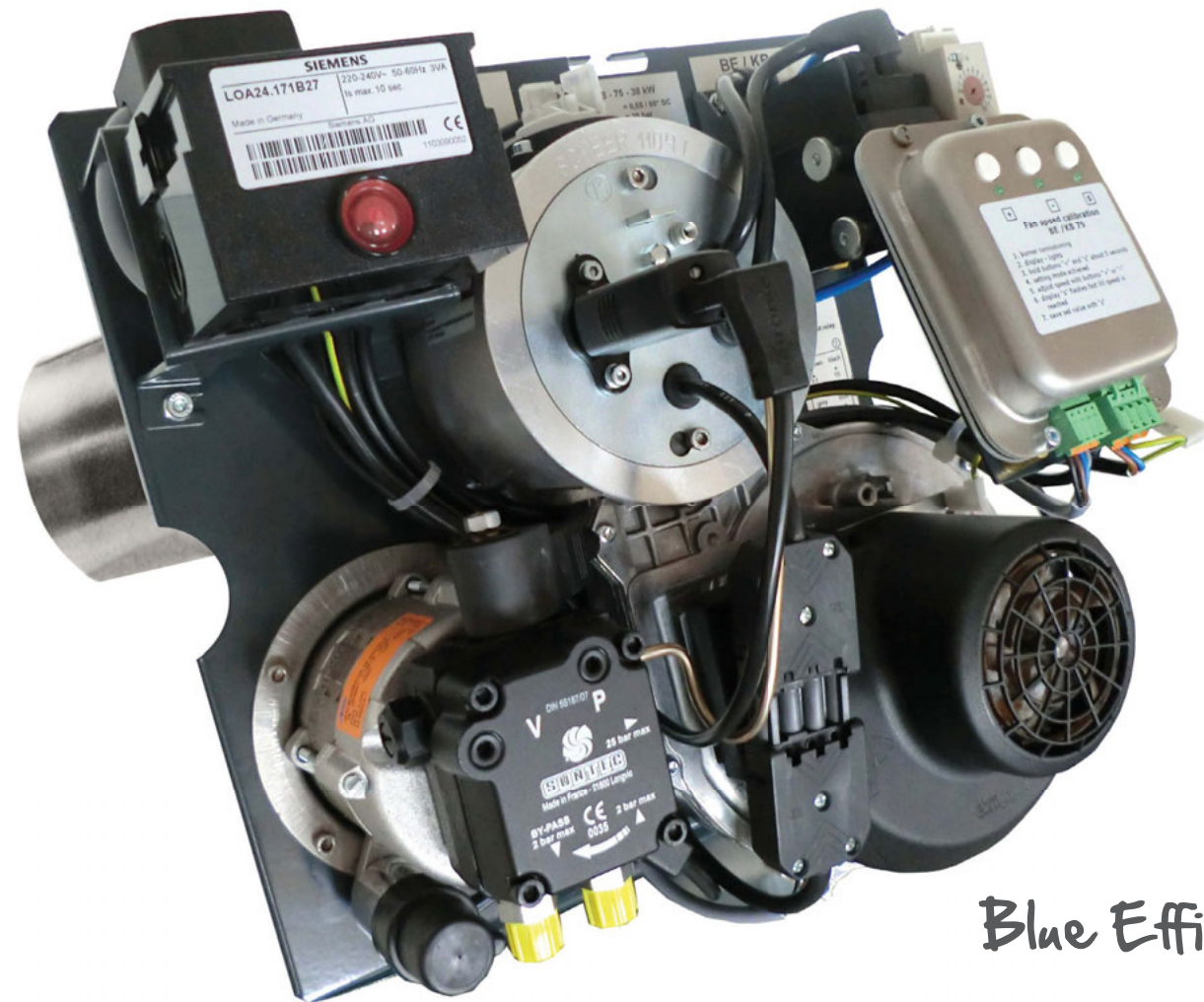

Blue Efficiency®

		HR 300	HR 400	HR 500
Blue efficiency	Type	BE 300	BE 400	BE 500
Efficiency	%	93	93	93
Oil flow	kg/h	1,07	0,92	1,96
Art. No.		015087	015088	015089

Telemonitoring of the heating system over a mobile phone.

- SMS message in case of malfunction of the heating system
- SMS message in case of power supply interruption
- SMS message in case the boiler or room temperature falls below the set temperature
- Manual retrieval of the temperatures
- Configurable via mobile phone
- Compatible for all heating systems with 230V lockout switch
- SMS text message to up to two phone numbers freely configurable
- Easy to retrofit
- Fault clearance of the heating system via SMS



SH-Telemonitoring

Art. No. 051700

For all common heating systems

The SH-Telemonitoring communicates via mobile phone. It is so possible to receive an immediate notification as soon as the heater deviates from the freely selectable parameters. In addition, the SH-Telemonitoring provides the ability to notify another phone number by SMS.

For example, in this way it is possible to inform the heating service or any other person about a possible malfunction in the heating system, and thus to enable an immediate response. Also when there is no malfunction, for example in order to retrieve information on the current state of the heating system, an SMS is sent to the SH-Telemonitoring and feedback on the current boiler temperature and room temperature is obtained. The SH-Telemonitoring offers the best possibilities for remote monitoring of the heating system. In this way chilly, unpleasant surprises become a thing of the past.